

130.00 mm

180.00 mm

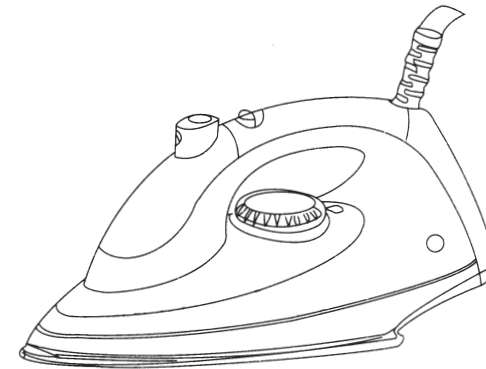

RM/179
ELECTRIC SPRAY IRON



- Set the appropriate ironing temperature indicated by the ironing instructions or by the fabric table by means of the temperature dial (fig.8).
- Insert plug into the wall socket. The pilot light will turn on (fig. 9).
- When the pilot light turns off and suddenly turns on again, you can start on ironing (fig. 10). The pilot light will turn on from time to time during ironing. This is just a normal operation of the iron.
- The pilot light will come on from time to time during ironing. This has no effect so simply continue.
- If you set the temperature control to a lower setting after ironing at a high temperature, do not recommence ironing before the pilot light comes on again.

Ironing tips

- Iron with a straight back. Adjust the height of the ironing board so that the handle of the iron is on the same level as your elbow.
- Pressing onto the iron is not necessary. provided that the temperature has been set correctly. Ironing is most effective if the laundry is slightly damp.

Spraying (for spray iron only)

At any temperature, by pushing on the spray button laundry can be dampened down (fig. 11).







When finished ironing

- Place the iron on its rear side (fig.12).
- Set the temperature dial to position "MIN" (fig. 13).
- Remove plug from the wall socket (fig.14).
- Let the iron cool for at least 30 minutes.
- You can wind up the cord (fig.15) and then fix the cord clip (fig.16).
- Store the iron standing on its rear side to prevent damage to soleplate (fig.17).

Cleaning

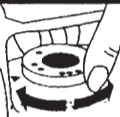
- Before cleaning remove the plug from the wall socket, let the iron cool
- The appliance can be cleaned with a damp cloth.

- Always refer to the ironing table temperature it is recommended to start at a low temperature and increase to one, which gives the required results.
- Velvet and other textures which rapidly acquire shiny spots should be ironed in one direction only (with the nap), applying only light pressure. Always keep the iron moving.
- Iron the reverse side of synthetic materials and silk to prevent shiny spots. To prevent staining, do not use the spray on silk or other delicate fabrics.

Table		
Label with ironing instructions	Kind of textile	Temperature dial
		
	Synthetic e.g. acetate, acrylic, viscose, polyamide, polyester. silk	MIN •
	Wool	••
	Cotton Linen	••• MAX
	Please note: This article cannot be ironed!	

Filling with water (for spray iron only)

- You can fill the water tank with normal tap water.
- Press the release button (fig.2) and remove the spray unit (fig.3).
- Pull out the spray button (fig.4).
- Fill the water tank (fig.5).
- Replace the spray button ("Click!") (fig.6).
- Replace the spray unit ("Click!") (fig.7).

Setting the temperature

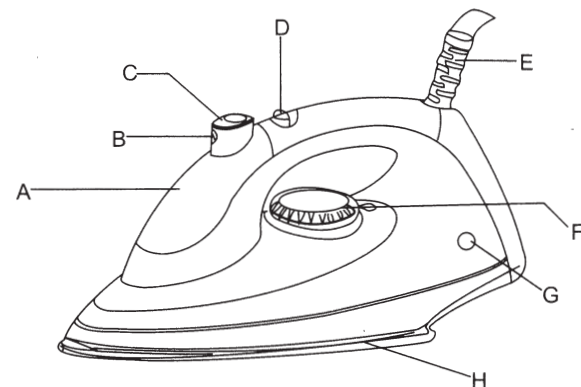

- A. Front hand grip
- B. Spray nozzle
- C. Spray button
- D. Water-tank separating button
- E. Supply cord
- F. Temperature control dial
- G. Supply pilot light
- H. Soleplate

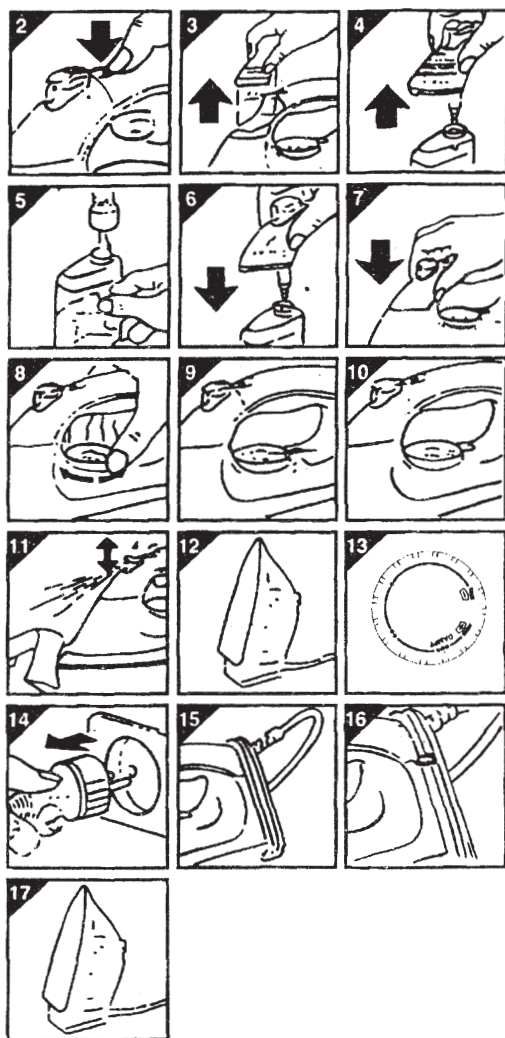

Important

- Please read these instructions for use carefully in conjunction with the illustrations before using the appliance.
- Never use the appliance if damaged in any way.
- Keep appliance out of the reach of children
- The cordset should not be allowed to touch the soleplate when it is hot.
- Never immerse the iron in water
- Always place the iron with its back on a firm flat surface when not in use
- Always unplug iron when unattended
- Keep the soleplate smooth; avoid contact with hard metal objects.
- Some parts of the iron have been slightly greased and as a result the iron might slightly smoke when connected for the first time. After a short while, however, this will cease.
- Do not leave the iron unattended while it is connected to the power supply.
- If the main cord is damaged, it must be replaced right away by its original type only.
- Don't leave the iron unattended when connected to the power outlet.

Ironing temperature

- Always check first if a label with ironing instructions is attached to the article to be ironed. (See table.) Follow these ironing instructions in all cases.
- If ironing instructions are missing but you know the kind of fabric, then see the table for recommended ironing temperatures.
- The table is valid for the fibre materials only.
- If some kind of finish has been applied (gloss, wrinkle, relief etc.), the textile can best be ironed at a low temperature.
- First sort out the fabrics according to ironing temperature: wool with wool, cotton with cotton, etc.
- The iron heats up quicker than it cools down. Therefore, start ironing the articles requiring the lowest temperature such as those made of synthetic fibres.
- Then progress to the higher temperatures. Finish by ironing cotton and linen.
- If the article is made of a mixture of different fibres, you must always select the lowest ironing temperature of the composition of those fibres. (E.g. an article consisting of "60% polyester and 40% cotton" should be ironed at the temperature indicated for polyester (-).